

The JBL logo is displayed in white, bold, sans-serif capital letters inside an orange square.

Simply Cinema™

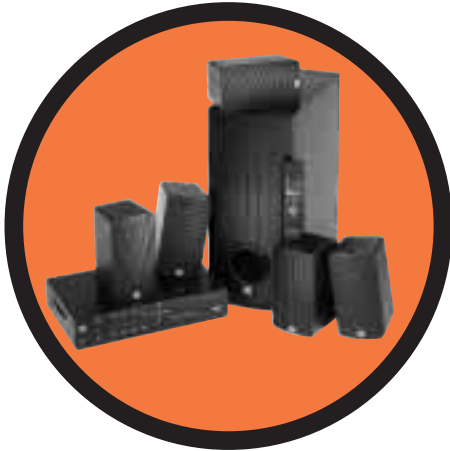

ESC200

simple

set-up guide

thank you for choosing JBL. For over 50 years, JBL has been involved in every aspect of musical and film recording and reproduction, from live performances to monitoring the recordings you play in your home, car, or office.

We're confident that the **JBL system** you have chosen will provide every note of enjoyment that you expected – and that when you think about purchasing additional audio equipment for your home, car, or office, you will once again choose JBL.

Please take a moment to complete the enclosed profile card. It enables us to keep you posted on our latest advancements, and helps us to better understand our customers and build products that meet your needs and expectations.

JBL Consumer Products

read first! Important Safety Precautions!

CAUTION

**RISK OF ELECTRIC SHOCK
DO NOT OPEN**

CAUTION: To prevent electric shock, do not remove the grounding plug on the power cord, or use any plug or extension cord that does not have a grounding plug provided.

Make certain that the AC outlet is properly grounded. Do not use an adapter plug with this product.



The lightning flash with arrowhead symbol, within an equilateral triangle, is intended to alert the user to the presence of uninsulated "dangerous voltage" within the product's enclosure that may be of sufficient magnitude to constitute a risk of electric shock to persons.



The exclamation point within an equilateral triangle is intended to alert the user to the presence of important operating and maintenance (servicing) instructions in the literature accompanying the appliance.

- 1. Read Instructions.** All the safety and operating instructions should be read before the product is operated.
- 2. Retain Instructions.** The safety and operating instructions should be retained for future reference.
- 3. Heed Warnings.** All warnings on the product and in the operating instructions should be adhered to.
- 4. Follow Instructions.** All operating and use instructions should be followed.
- 5. Cleaning.** Unplug this product from the wall outlet before cleaning. Do not use liquid cleaners or aerosol cleaners. Use a damp cloth for cleaning.
- 6. Attachments.** Do not use attachments not recommended by the product manufacturer as they may cause hazards.
- 7. Water and Moisture.** Do not use this product near water – for example, near a bathtub, wash bowl, kitchen sink or laundry tub; in a wet basement; or near a swimming pool; and the like.
- 8. Accessories.** Do not place this product on an unstable cart, stand, tripod, bracket, or table. The product may fall, causing serious injury to a child or adult, and serious damage to the product. Use only with a cart, stand, tripod, bracket, or table recommended by the manufacturer, or sold with the product. Any mounting of the product should follow the manufacturer's instructions, and should use a mounting accessory recommended by the manufacturer.
- 9. A product and cart combination should be moved with care.** Quick stops, excessive force, and uneven surfaces may cause the product and cart combination to overturn.
- 10. Ventilation.** Slots and openings in the cabinet are provided for ventilation and to ensure reliable operation of the product and to protect it from overheating, and these openings must not be blocked or covered. The openings should never be blocked by placing the product on a bed, sofa, rug, or other similar surface. This product should not be placed in a built-in installation such as a bookcase or rack unless proper ventilation is provided or the manufacturer's instructions have been adhered to.

11. Power Sources. This product should be operated only from the type of power source indicated on the marking label. If you are not sure of the type of power supply to your home, consult your product dealer or local power company. For products intended to operate from battery power, or other sources, refer to the operating instructions.

12. Grounding or Polarization. This product may be equipped with a polarized alternating-current line plug (a plug having one blade wider than the other). This plug will fit into the power outlet only one way. This is a safety feature. If you are unable to insert the plug fully into the outlet, try reversing the plug. If the plug should still fail to fit, contact your electrician to replace your obsolete outlet. Do not defeat the safety purpose of the polarized plug.

13. Power-Cord Protection. Power-supply cords should be routed so that they are not likely to be walked on or pinched by items placed upon or against them, paying particular attention to cords at plugs, convenience receptacles, and the point where they exit from the product.

14. Nonuse Periods. The power cord of the product should be unplugged from the outlet when left unused for long periods of time.

15. Outdoor Antenna Grounding. If an outside antenna or cable system is connected to the product, be sure the antenna or cable system is grounded so as to provide some protection against voltage surges and built-up static charges. Article 810 of the National Electrical Code, ANSI/NFPA 70, provides information with regard to proper grounding of the mast and supporting structure, grounding of the lead-in wire to an antenna discharge unit, size of grounding conductors, location of antenna-discharge unit, connection to grounding electrodes, and requirements for the grounding electrode. See Figure 1.

16. Lightning. For added protection for this product during a lightning storm, or when it is left unattended and unused for long periods of time, unplug it from the wall outlet and disconnect the antenna or cable system. This will prevent damage to the product due to lightning and power-line surges.

17. Power Lines. An outside antenna system should not be located in the vicinity of overhead power lines or other electric light or power circuits, or where it can fall into such power lines or circuits. When installing an outside antenna system, extreme care should be taken to keep from touching such power

lines or circuits, as contact with them might be fatal.

18. Overloading. Do not overload wall outlets, extension cords, or integral convenience receptacles, as this can result in a risk of fire or electric shock.

19. Object and Liquid Entry. Never push objects of any kind into this product through openings, as they may touch dangerous voltage points or short-out parts that could result in a fire or electric shock. Never spill liquid of any kind on the product.

20. Servicing. Do not attempt to service this product yourself, as opening or removing covers may expose you to dangerous voltage or other hazards. Refer all servicing to qualified service personnel.

21. Damage Requiring Service. Unplug this product from the wall outlet and refer servicing to qualified service personnel under the following conditions:

- a. The power-supply cord or the plug has been damaged; or
- b. Objects have fallen onto, or liquid has been spilled into, the product; or
- c. The product has been exposed to rain or water; or
- d. The product does not operate normally when following the operating instructions. Adjust only those controls that are covered by the operating instructions, as an improper adjustment of other controls may result in damage and will often require extensive work by a qualified technician to restore the product to its normal operation; or
- e. The product has been dropped or damaged in any way; or
- f. The product exhibits a distinct change in performance – this indicates a need for service.

22. Replacement Parts. When replacement parts are required, be sure the service technician has used replacement parts specified by the manufacturer or that have the same characteristics as the original part. Unauthorized substitutions may result in fire, electric shock or other hazards.

23. Safety Check. Upon completion of any service or repairs to this product, ask the service technician to perform safety checks to determine that the product is in proper operating condition.

24. Wall or Ceiling Mounting. The product should be mounted to a wall or ceiling only as recommended by the manufacturer.

25. Heat. The product should be situated away from heat sources such as radiators, heat registers, stoves, or other products (including amplifiers) that produce heat.

Part No. JBLULB 6/96

Figure 1.
Example of Antenna
Grounding as per National
Electrical Code,
ANSI/NFPA 70

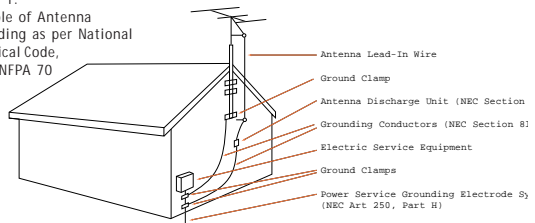

included

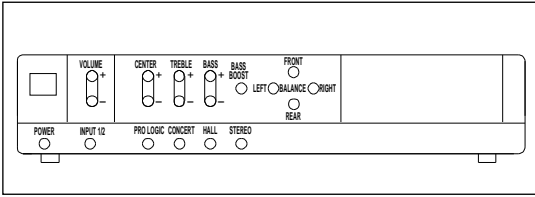

Dolby* Pro Logic* processor with 6 amplifiers.

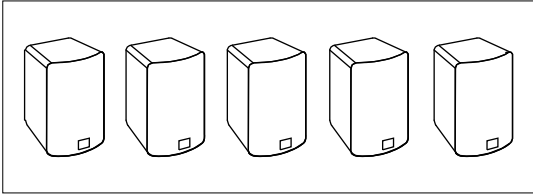

Front, rear and center speakers with rotating logo.

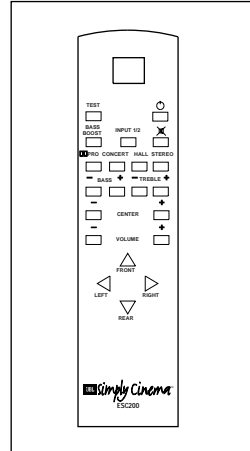

Remote.

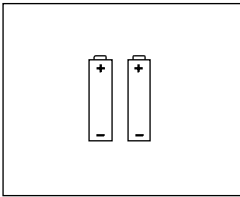

Batteries.

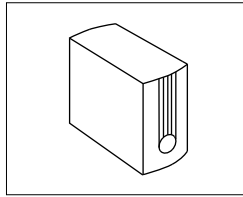

Subwoofer.

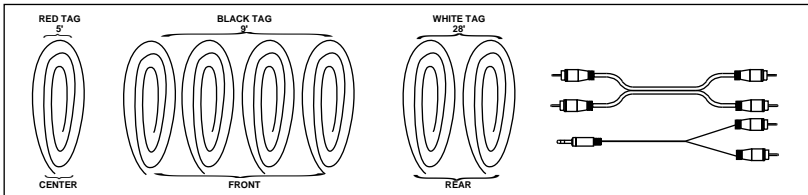

Cables.

Wall-Mounting Your ESC200 Satellites

The ESC200 Satellites may be wall-mounted. The customer is responsible for proper selection and use of mounting

hardware available through hardware stores to properly and safely wall-mount the ESC200 Satellites. This product is not intended for ceiling mounting.

one. Speaker Placement

Front

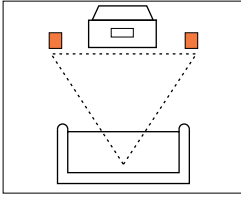

Center

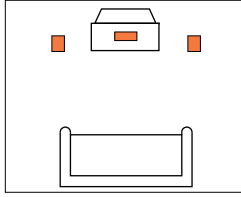

Place the center speaker even with the left and right speakers, or slightly behind.

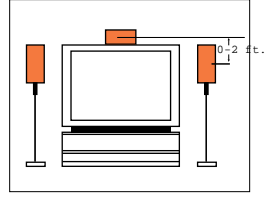

Place all three front speakers at approximately the same height. (Height of ears preferable.)

Rear

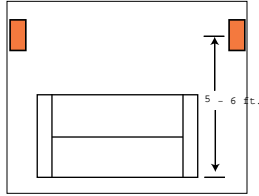
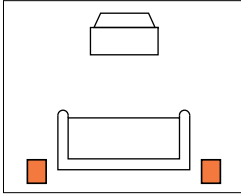

Subwoofer

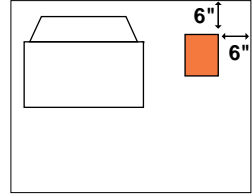

Optimum subwoofer placement, positioned vertically or horizontally.

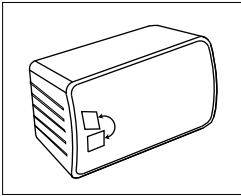

Rotating logo. Pull out gently and turn.

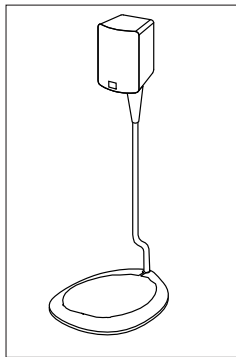

On optional stands.
Part No. FS10/20.

two. Speaker Connections

To connect your speakers, press down on the quick release tab, which opens the terminal for the speaker wire, and put the wire in straight. Release the tab and give the speaker wire a gentle tug. If it's in properly, it won't "give" at all. If it slides, repeat the procedure.

Use the shortest wire for the CENTER speaker, the two medium length wires for the FRONT speakers, and the long wires for the REAR speakers.

Always insert the RED coated wire into the RED terminal and the BLACK coated wire into the BLACK terminal on each of your

speakers and the appropriate terminal on the back of the PROCESSOR.

Back of Speaker

Red Black
Make sure you match RED to RED and BLACK to BLACK on both ends.

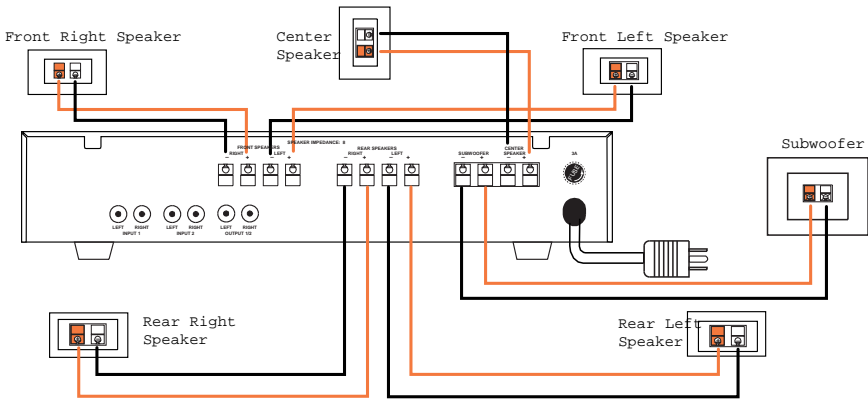

three. Source Connection (TV or VCR)

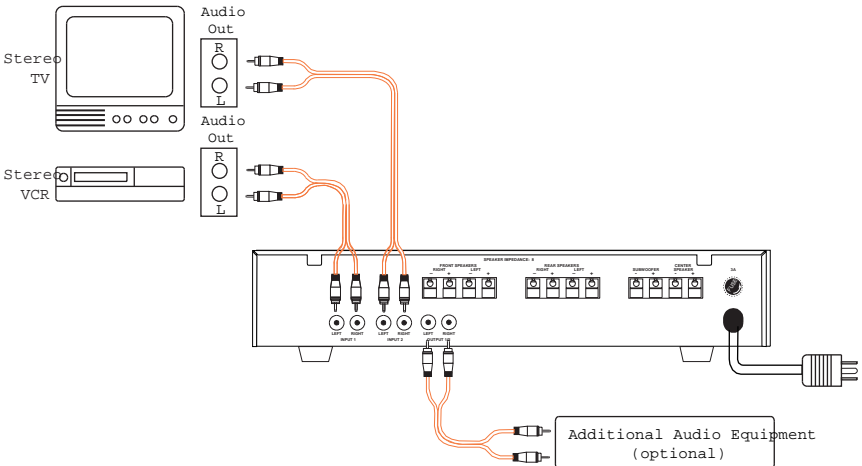

four. Source Connection (Headphone)

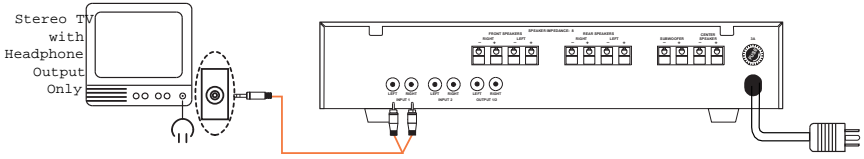

five. Plug-In

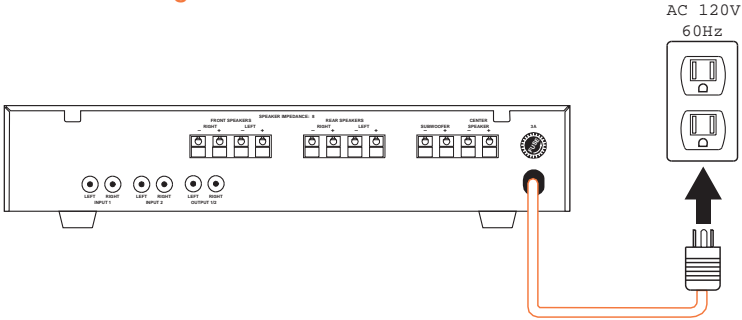

six. Test

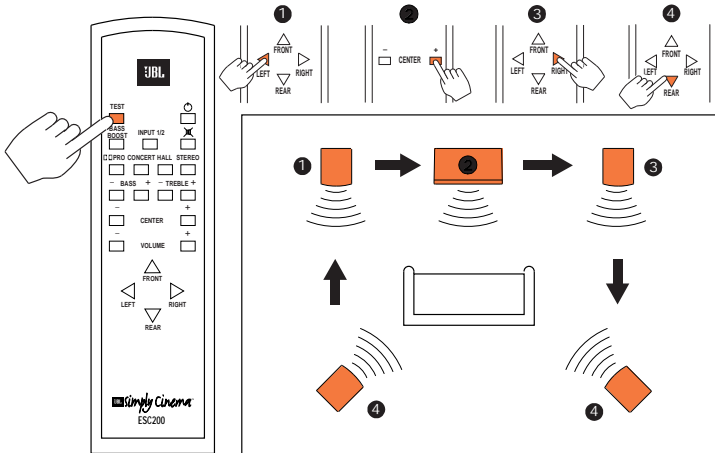

seven. Surround Modes

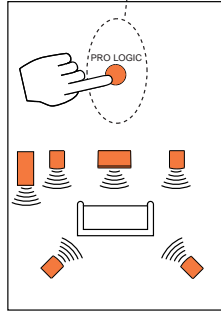
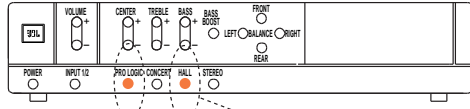
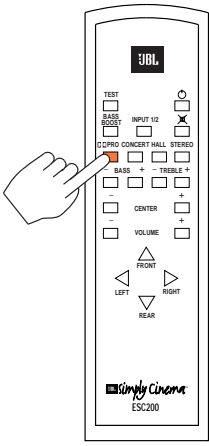

Pro Logic mode.

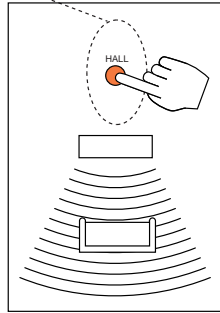

Hall mode.

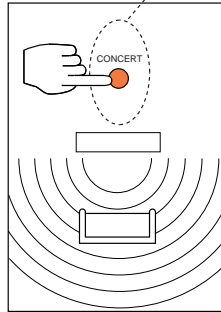
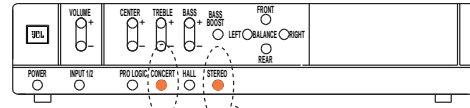
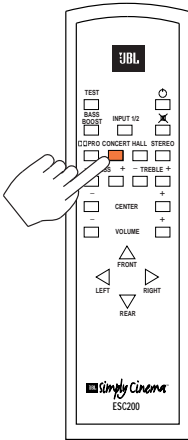
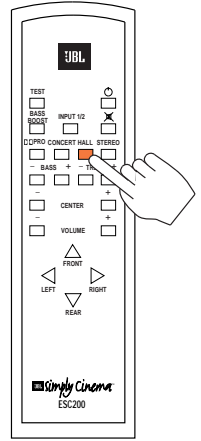

Concert mode.

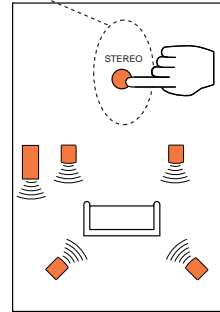

Stereo mode.

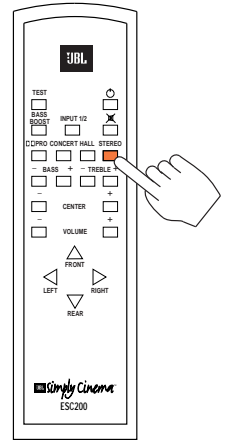

eight. Volume

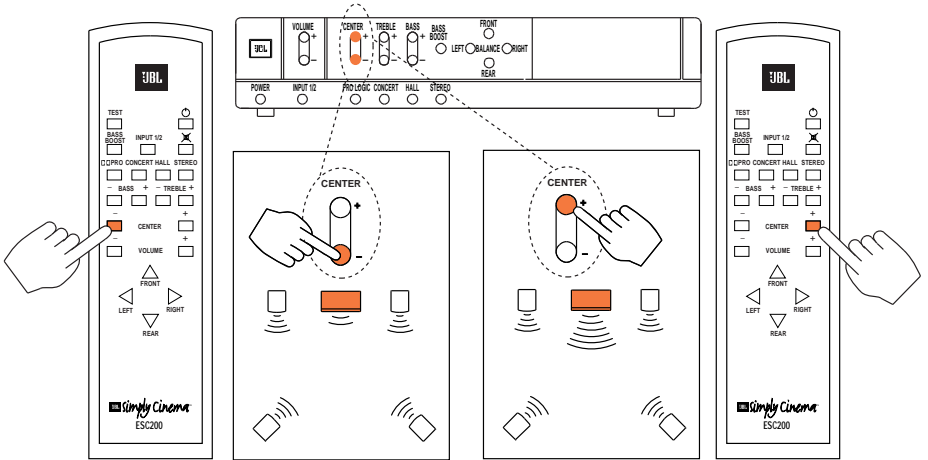
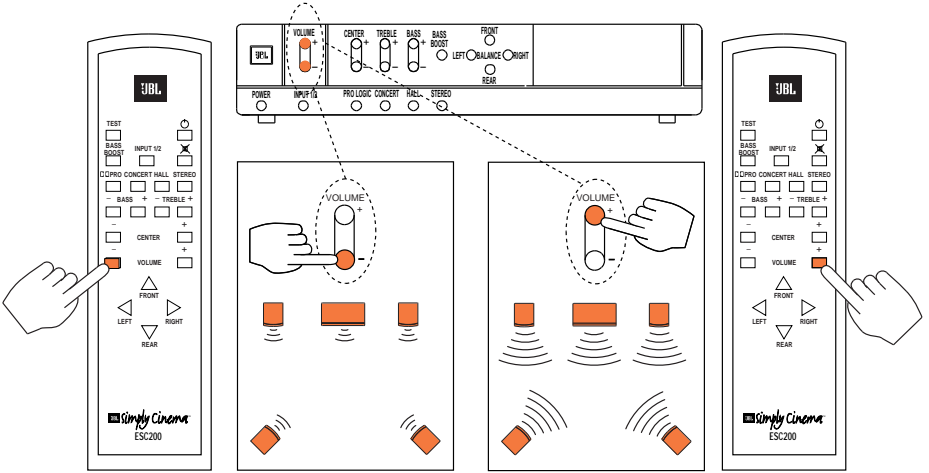

nine. Balance

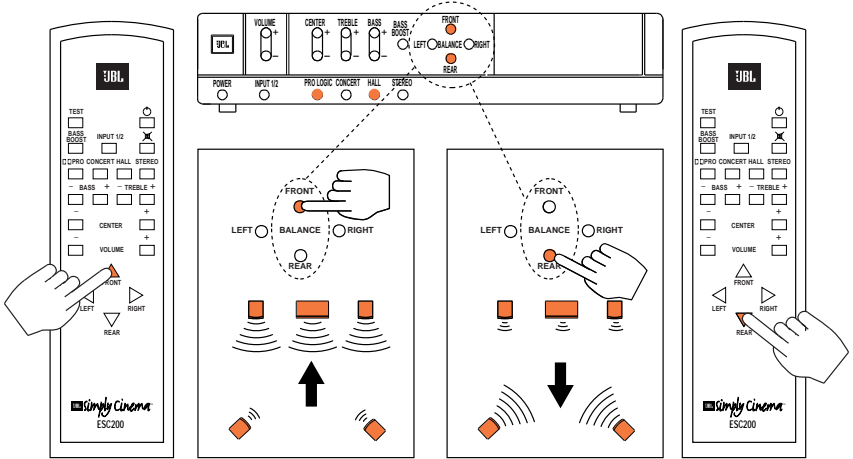
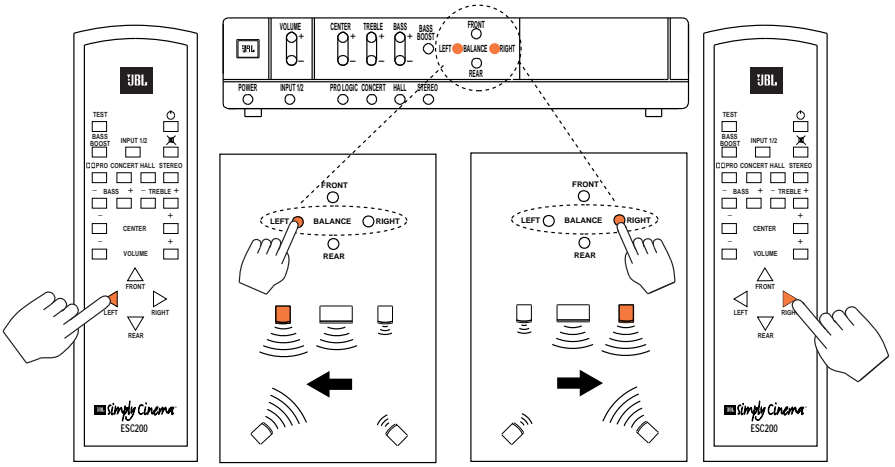

ten. Bass & Treble

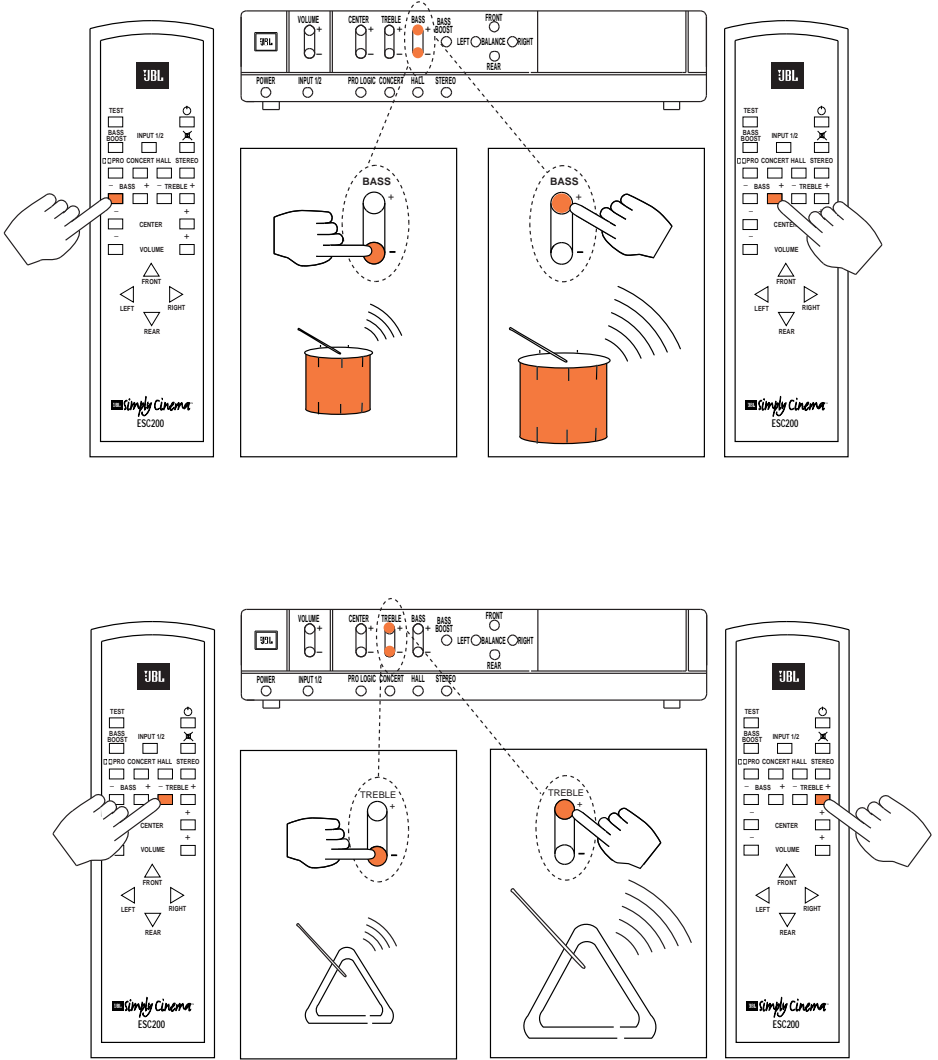

eleven. Bass Boost

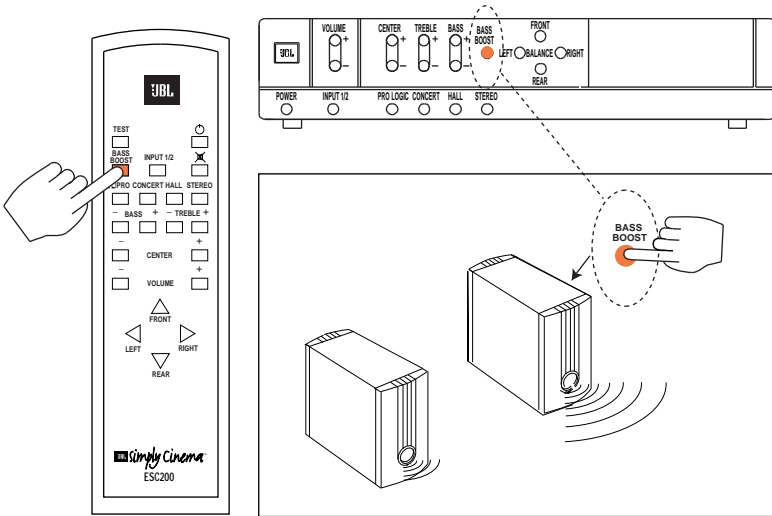

Troubleshooting

If you hear no sound at all, check the following:

- Make sure the processor/amplifier is plugged into a live electrical outlet and that the power switch is on.
- Check the connections from the TV or VCR to the processor/amplifier.
- If using with a television, make sure the TV is on and a signal is present.
- If using with a VCR, make sure the VCR is playing a tape.
- Check all connections between processor/amplifier and each of the speakers.

If one or more of the speakers does not play, check the following:

- Check all connections between processor/amplifier and each of the speakers.
- Adjust the balance controls from left to right and front to rear.

If you have very little bass output, check the following:

- Make sure the subwoofer is connected properly to the processor/amplifier.
- Experiment with placement of the subwoofer. Remember, place the subwoofer in a corner to get maximum bass output from the system.
- Make sure "Bass Boost" is on.
- Adjust "Bass" level.

If there is no sound coming from the rear speakers or the volume is very low, check the following:

- Check all connections between processor/amplifier and each of the speakers.
- Adjust the front-rear balance controls on the processor/amplifier.
- Make sure the TV show or movie you are watching is recorded in Dolby* Surround. If it is not, try the "Concert Hall" or "Stereo" settings on the processor/amplifier.

Specifications

Satellite Speakers

Power Handling (RMS)

20 watts

Frequency Response

120Hz – 20kHz

Sensitivity (1 watt/1 meter)

87dB

Nominal Impedance

8 ohms

Woofer Size

3"

Tweeter Size

1"

Dimensions (HxWxD)

4-1/16 x 7-1/2 x 7-3/8 inches

103 x 190 x 187mm

Subwoofer

Power Handling (RMS)

60 watts

Frequency Response

35Hz – 200Hz

Sensitivity (1 watt/1 meter)

90dB

Nominal Impedance

6 ohms

Woofer Size

6-1/2"

Dimensions (HxWxD)

7-3/4 x 13-7/8 x

17-3/4 inches

198 x 354 x 451mm

Processor Amplifier

Total Maximum

Amplifier Output

100 watts

Dimensions (HxWxD)

2-11/16 x 13-1/2 x 9 inches

69 x 343 x 230mm

Occasional refinements may be made to existing products without notice, but will always meet or exceed original specifications unless otherwise stated.



JBL Consumer Products

250 Crossways Park Drive, Woodbury, NY 11797

8500 Balboa Boulevard, Northridge, CA 91329

1-800-336-4JBL (4525) (USA only)

©1996 JBL, Incorporated. JBL and Simply Cinema are registered trademarks of JBL, Incorporated.

*Trademarks of Dolby Laboratories.

Printed in USA 9/96 ♻ Part No. ESC200M

H A Harman International Company